

1988 - 2018

30
YEARS

32ND EDITION

ATTO
Product Brochure
The Power Behind the Storage

ATTO

ATTO Technology, Inc.

Corporate Vision

For 30 years, ATTO has been an innovator in storage and network connectivity, from developing the first solid-state storage device to the latest data center appliances. ATTO develops high-performance products that manage latency in the most demanding real-time environments, resulting in accelerated application performance and enhanced transaction processing. ATTO delivers performance-based solutions to applications, infrastructure, big data, cloud and virtualized environments, including:

- Enterprise - Database, Web Servers, Back-Office Operations
- Departmental - Business Analytics, Supply Chain, Asset Management
- Business Continuity - MetroClusters
- Workgroup - CAD/CAE, Video Production/Finishing, Scientific, Energy, Medical

ATTO manufactures the industry's broadest portfolio of high-performance storage and network connectivity products, designed and optimized to work together to help customers better store, manage, analyze and deliver data.

- Fibre Channel, SAS/SATA, iSCSI, Ethernet, Thunderbolt™, NVMe, NVMe over Fabric, Host Bus Adapters, RAID Adapters, Network Interface Cards, storage controllers, Bridges, Thunderbolt™ adapters and software

ATTO delivers tested solutions which are qualified and certified with industry leading workstation, server, storage and application vendors. This ensures:

- Faster access to new technology
- Features that improve your workflow
- Maximized solution performance and productivity

ATTO provides a unique level of partnership with customers, solution providers and OEMs.



ATTO Founders Dave Snell, CTO, and Tim Klein, CEO

The Power Behind the Storage

"We would like to thank our valued industry partners and loyal customers for your continued support. ATTO's primary mission is to provide the best possible customer experience while offering the highest performing, industry leading products and technologies available."

-Timothy J. Klein, President and CEO, ATTO Technology, Inc.

ATTO Product Lines



Host and RAID Adapters

Celerity™ Fibre Channel HBAs and ExpressSAS® SAS/SATA HBAs and RAID adapters provide faster and more efficient data transfers



Network Interface Cards

FastFrame™ 10/25/40/50/100 Gb Ethernet NICs provide flexible and scalable unified LAN and SAN storage connectivity



Storage Controllers

XstreamCORE™ Ethernet and Fibre Channel storage controllers disaggregate storage from compute by enabling remote access and sharing of SAS, JBOD, JBOF, RAID, Tape and optical devices.

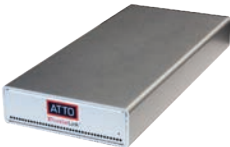

Thunderbolt™ Adapters

ThunderLink® adapters enable high-performance, low latency Thunderbolt connectivity to desktop and mobile workstations for storage and network connectivity



Bridges

FibreBridge® products allow IT administrators to connect SAS HDD, JBOF, JBOD and tape devices into storage area networks



Software

ATTO software and downloadable tools help to maximize the productivity of a number of ATTO products

Industry Partners



Technology Leadership

ATTO Product Differentiators

ATTO Advanced Data Streaming (ADS™)

ADS latency management technology is built into every ATTO host bus adapter (HBA), Thunderbolt™, NIC and RAID controller. ADS ensures the fastest, most consistent time-to-data, delivering the best-in-industry aggregate bandwidth and predictable data transfers for high-performance applications.

ATTO Products with ADS Technology

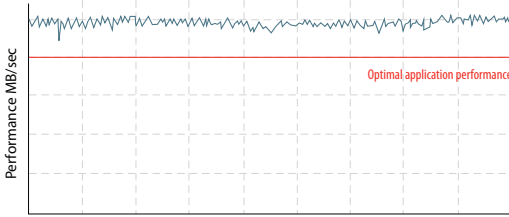

Data transfer performance is smooth and reliable

Competitor's Product

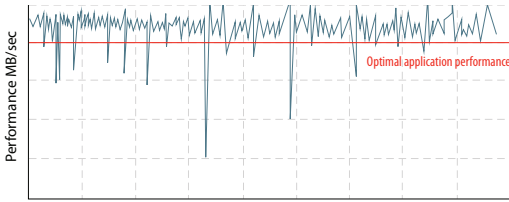

Disrupted transfer with peaks and drops

Transfer rate dips below optimal performance levels

ATTO's heritage of pioneering solid-state storage technology means all products are engineered to manage latency in real-time environments:

- Higher application performance means improved productivity
- Processing more transactions in a shorter amount of time means more revenue and better business decisions
- Ability to handle larger workloads and client counts

ATTO
Solutions

HBAs

RAID
Adapters

NIC/HBAs

Storage
Controllers

Thunderbolt™
Adapters

Bridges

Software

Adaptive Path Optimization

Performance Plus Protection

ATTO Adaptive Path Optimization has built-in intelligence to sense when multiple paths to drives are available and directs I/O accordingly. For the cost of a cable, you can see up to a 70% performance improvement. The ExpressSAS® RAID adapter automatically configures and reconfigures for optimum I/O balance and is scalable to work with cascaded arrays and expanders.

Maximum Availability

Up to two-thirds of storage failures are caused by interconnect issues. Adaptive Path Optimization eliminates single points of failure in storage connections by creating redundant data paths. Fast, dynamic rebalancing minimizes disruptions and quickly restores a balanced configuration that delivers predictable access to data.

ATTO Products with Adaptive Path Optimization Technology - ExpressSAS® SAS/SATA RAID adapters

ATTO CacheAssure Technology™

No Batteries, Lifetime Backup

Power and system failures can cause data located in cache memory to become permanently lost. Traditionally, battery backup units (BBUs), which typically last one to two years, have been used to protect and recover cached data but they require constant monitoring, maintenance and replacement and only protect data for up to 72 hours after a failure. ATTO RAID products with CacheAssure Technology™ deliver a long-lasting and reliable cached data protection solution all without the worries associated with battery-based technology.

Zero Maintenance Data Protection

CacheAssure saves time and money by eliminating the need to install, monitor, maintain, dispose of and replace batteries. It provides protection within a few minutes of installation while batteries can take six to eight hours to recharge, putting data at risk. Contents in cache memory get saved immediately in the event of a system failure or power loss and can remain protected for up to 10 years. Unlike other solutions that risk data loss immediately upon power restoration, CacheAssure ensures storage is back online before restoring and synchronizing data.

ATTO products with CacheAssure Technology - ExpressSAS® SAS/SATA RAID adapters

"Working with ATTO over the past two years has led to solutions that provide ease-of-use, solid interoperability and support for our joint storage solutions."

*— Don Lopes
Director of Channel and Inside Sales, Nexenta*

ATTO DriveAssure™ Technology

Extend the Life of Your Drives

Studies show that up to 60% of IT budgets are spent on maintenance. DriveAssure™ searches for bad sectors or slow spots and repairs them without failing the drive, preventing the loss of critical assets and ensuring drives run longer, smoother and faster. Drives are groomed to effectively extend their useful life, reducing maintenance costs.

Maximize System Uptime

Fast access to, and rapid delivery of data is critical in today's data center environments. DriveAssure compensates for a slow drive in a RAID group to keep data moving smoothly within a guaranteed response time. In the event of a drive failure the RAID group is rebuilt up to 50% faster than competitive solutions, all while providing 100% data delivery performance to the client.

ATTO products with DriveAssure technology - ExpressSAS® SAS/SATA RAID adapters

ATTO MultiPath Director™

Enhancing High-Performance Applications

Workstation-based applications in high-performance workgroup environments require fast throughput and uninterrupted access to data. In a typical workgroup setup, a server links workstations to storage with data residing on shared resources in a storage area network, or SAN — a configuration that adds latency, increases complexity and generally does not support the high performance level required by today's data-intensive workstation applications, like seismic exploration, scientific research, medical imaging and media production. The only other alternative is to use direct-attached storage for each workstation, an option that creates islands of unprotected data and makes it difficult to share projects.

Superior Performance

MultiPath Director™ solves performance problems by offering the unique option to bypass servers and connect Windows®, Linux® and macOS® workstations directly to enterprise-class storage, providing a completely redundant, high-availability, high-performance storage solution for workstation applications. Redundant data paths with failover protection automatically route data to a secondary path in the event of a primary link, cable or switch failure, guaranteeing uninterrupted access for mission-critical applications. Load-balancing features use multiple paths to optimize data transfers, effectively eliminating bottlenecks that can drag down application performance. Load balancing and failover protection do not exist in most workstation operating systems. By incorporating these features at the driver level, ATTO provides the only solution that allows Windows, Linux, and macOS workstations to work together in a heterogeneous SAN.

ATTO products with MultiPath Director Technology – Celerity™ Fibre Channel HBAs and ThunderLink® adapters

ATTO
Solutions

HBAs

RAID
Adapters

NICHBAs

Storage
Controllers

Thunderbolt™
Adapters

Bridges

Software

32Gb, 16Gb and 8Gb Fibre Channel HBAs

ATTO Celerity™ Host Bus Adapters

Celerity™ Fibre Channel HBAs are designed to cover the full performance spectrum from enterprise to workgroup and server to workstation environments. This highly integrated, fully scalable family of adapters is engineered to optimize data transfer using a combination of features that enhance the data delivery process and is fully scalable. ATTO Celerity 32 and 16Gb Gen 6 single-, dual- and quad channel HBAs further enhance speed and reliability in high-bandwidth work environments. Celerity Gen 6 HBAs address the need for high-performing, scalable and secure storage to support exponential data growth from applications. With features including Forward Error Correction, the Gen 6 portfolio ensures high reliability in demanding, high-speed networks. Built with the PCIe 3.0 computer interface, Gen 6 host adapters are compatible with all Fibre Channel 32, 16, 8 and 4Gb devices.

- Optimized for extremely low latency and high-bandwidth transfers
- Engineered to meet today's high-performance applications, PCIe 3.0 servers and SSD demands with up to 1.6 million IOPS on a single port
- Designed to support real-time virtual environments resulting in higher application performance, better transaction processing and the ability to handle larger workloads
- Enterprise storage-ready compatible with Dell EMC™, HP®, Hitachi Data Systems, IBM®, NetApp®, Quantum® and other major storage vendors
- MultiPath Director™ is the industry's only solution to allow servers and workstations access to high-availability, high-performance, enterprise-class storage for shared workflows
- MultiPath Director implemented across all clients (servers and workstations) improves overall efficiency of the Fibre Channel SAN infrastructure
- Low power consumption expands system performance resources to extend processing capabilities



Supports:

- Linux®, macOS®, Windows®, Windows Server Hyper-V®, VMware®, FreeBSD, illumos
- Direct fabric/switch attach and point-to-point
- Certified with industry leading platforms and applications
- N-Port ID Virtualization and Virtual Fabric
- Initiator and Target Mode support

Includes:

- Advanced Data Streaming (ADS™) Technology
- Pluggable optical SFP+
- ATTO ConfigTool™ for customized performance settings

Complementary Products:

- ATTO XstreamCORE™ storage controllers
- ATTO FibreBridge® Fibre Channel storage controllers
- ATTO ThunderLink® adapters
- ATTO premium cables

"ATTO is the leader in providing world-class HBAs so we're pleased to be able to offer these options to our customers."

*– Gary Watson
CTO, Nexsan*

ATTO Celerity™ 32Gb Fibre Channel Host Bus Adapters

Product Features	FC-324E	FC-322E	FC-321E
Part Number	CTFC-324E-000	CTFC-322E-000	CTFC-321E-000
Fibre Channel Ports	4	2	1
Max. Data Rate	32Gb/s	32Gb/s	
Max. Transfer Rate	12800MB/s	6400MB/s	3200MB/s
Bus Type	PCIe 3.0 x16	PCIe 3.0 x8	PCIe 3.0 x8
Auto Negotiation	32Gb, 16Gb, 8Gb	32Gb, 16Gb, 8Gb	32Gb, 16Gb, 8Gb
Connector Type	Optical SFP+ LC	Optical SFP+ LC	Optical SFP+ LC
Max. Cable Length (OM3)	100m - 16Gb 50m - 32Gb	100m - 16Gb 50m - 32Gb	100m - 16Gb 50m - 32Gb
Low-Profile Form Factor	No	Yes	Yes
Developer's Kit ¹ (Target Mode API)	Yes	Yes	Yes
Warranty	3 year	3 year	3 year

ATTO Celerity 16Gb Fibre Channel Host Bus Adapters

Product Features	FC-164P	FC-162P	FC-161P
Part Number	CTFC-164P-000	CTFC-162P-000	CTFC-161P-000
Fibre Channel Ports	4	2	1
Max. Data Rate	16Gb/s	16Gb/s	16Gb/s
Max. Transfer Rate	6400MB/s	3200MB/s	1600MB/s
Bus Type	PCIe 3.0 x8	PCIe 3.0 x8	PCIe 3.0 x8
Auto Negotiation	16Gb, 8Gb, 4Gb	16Gb, 8Gb, 4Gb	16Gb, 8Gb, 4Gb
Connector Type	Optical SFP+ LC	Optical SFP+ LC	Optical SFP+ LC
Max. Cable Length (OM3)	150m - 8Gb 100m - 16Gb	150m - 8Gb 100m - 16Gb	150m - 8Gb 100m - 16Gb
Low-Profile Form Factor	Yes	Yes	Yes
Developer's Kit ¹ (Target Mode API)	Yes	Yes	Yes
Warranty	3 year	3 year	3 year

ATTO Celerity 8Gb Fibre Channel Host Bus Adapters

Product Features	FC-84EN	FC-82EN	FC-81EN
Part Number	CTFC-84EN-000	CTFC-82EN-000	CTFC-81EN-000
Fibre Channel Ports	4	2	1
Max. Data Rate	8Gb/s	8Gb/s	8Gb/s
Max. Transfer Rate	3200MB/s	1600MB/s	800MB/s
Bus Type	PCIe 2.0 x8 ²	PCIe 2.0 x8 ²	PCIe 2.0 x8 ²
Auto Negotiation	8Gb, 4Gb, 2Gb	8Gb, 4Gb, 2Gb	8Gb, 4Gb, 2Gb
Connector Type	Optical SFP+ LC	Optical SFP+ LC	Optical SFP+ LC
Max. Cable Length (OM3)	500m - 2Gb 380m - 4Gb 150m - 8Gb	500m - 2Gb 380m - 4Gb 150m - 8Gb	500m - 2Gb 380m - 4Gb 150m - 8Gb
Low-Profile Form Factor	No	Yes	Yes
Developer's Kit ¹ (Target Mode API)	Yes	Yes	Yes
Warranty	3 year	3 year	3 year

¹ Available for qualified OEM sales only. Please contact your ATTO representative.

Compatible storage controllers available - see page 14.

Compatible software available - see page 20.

Compatible cables & accessories available.

ATTO
Solutions

HBAS
Fibre Channel

RAID
Adapters

NICHBAS

Storage
Controllers

Thunderbolt™
Adapters

Bridges

Software

12Gb and 6Gb SAS/SATA HBAs

ATTO ExpressSAS® Host Bus Adapters

ExpressSAS® HBAs leverage the performance and scalability enhancements of serial attached SCSI (SAS) technology to deliver the fastest available connection to SAS/SATA storage. They offer a reliable direct-attached storage connectivity solution that is interoperable with a wide range of internal and external disk and tape products. ExpressSAS 12Gb SAS/SATA HBAs feature PCI Express 3.0 bus technology in a low-profile form factor and offer the latest miniSAS HD connectors for improved cable management and monitoring.

- Optimized for extremely low latency and high-bandwidth transfers for both data-intensive and high-transaction rate applications
- Compatible with all major SAS/SATA solid-state disk, hard disk and tape drives
- Use up to 40% less power than competitive HBAs, reducing overall power and cooling costs
- Low power consumption expands system performance resources and extends processing capabilities

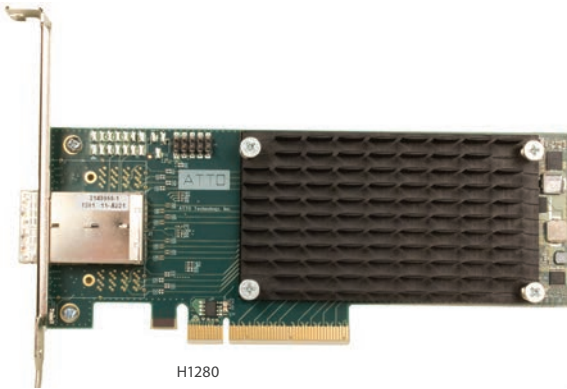

Supports:

- macOS® Windows®, Linux®, VMware®, FreeBSD® (12Gb only), illumos (12Gb only)
- Power Center Pro RAID 0, 1, 10, 1e (12Gb Only)
- Up to 2048 end point devices
- Certified with industry leading platforms and applications
- Initiator and Target Mode support

Includes:

- Advanced Data Streaming (ADS™) Technology
- ATTO ConfigTool™ for customized performance settings
- WriteStop™ technology for data security in digital forensic applications

Complementary Products:

- ATTO ThunderLink® adapters
- ATTO premium cables

ATTO ExpressSAS HBAs are available with a wide selection of 8, 12 and 16 port options to support a connection to storage from servers and workstations in datacenters, data warehousing, video on demand and other high availability, high performance applications.

ATTO ExpressSAS® SAS/SATA Host Bus Adapters

Product Features	H12F0	H120F	H1280	H1208
Part Number	ESAH-12F0-000	ESAH-120F-000	ESAH-1280-000	ESAH-1208-000
SAS/SATA Ports	16	16	8	8
Port Config. (Ext./Int)	16/0	0/16	8/0	0/8
Max. Data Rate	12Gb/s	12Gb/s	12Gb/s	12Gb/s
Bus Type	PCIe 3.0 x8	PCIe 3.0 x8	PCIe 3.0 x8	PCIe 3.0 x8
Connector Type	(4) 12Gb mini SAS HD (x4) SFF 8644 External	(4) 12Gb mini SAS HD (x4) SFF 8643 Internal	(2) 12Gb mini SAS HD (x4) SFF 8644 External	(2) 12Gb mini SAS HD (x4) SFF 8643 Internal
Max. Cable Length (SAS/SATA) ¹	100m/1m	100m/1m	100m/1m	100m/1m
Low-Profile Form Factor	Yes	Yes	Yes	Yes
Developer's Kit ² (Target Mode)	Yes	Yes	Yes	Yes
End Devices Supported	2048	2048	1024	1024
Warranty	3 year	3 year	3 year	3 year

Product Features	H1244	H1288
Part Number	ESAH-1244-000	ESAH-1288-000
SAS/SATA Ports	8	16
Port Config. (Ext./Int)	4/4	8/8
Max. Data Rate	12Gb/s	12Gb/s
Bus Type	PCIe 3.0 x8	PCIe 3.0 x8
Connector Type	(1) 12Gb miniSAS HD (x4) SFF 8644 External (1) 12Gb miniSAS HD (x4) SFF 8643 Internal	(2) 12Gb miniSAS HD (x4) SFF 8644 External (2) 12Gb miniSAS HD (x4) SFF 8643 Internal
Max. Cable Length (SAS/SATA) ¹	100m/1m	100m/1m
Low-Profile Form Factor	Yes	Yes
Developer's Kit ² (Target Mode)	Yes	Yes
End Devices Supported	1024	1024
Warranty	3 year	3 year

Product Features	H680	H608	H644
Part Number	ESAS-H680-000	ESAS-H608-000	ESAS-H644-000
SAS/SATA Ports	8	8	8
Port Config. (Ext./Int)	8/0	0/8	4/4
Max. Data Rate	6Gb/s	6Gb/s	6Gb/s
Bus Type	PCIe 2.0 ³ x8	PCIe 2.0 ³ x8	PCIe 2.0 ³ x8
Connector Type	(2) 6Gb mini SAS (x4) SFF 8088 External	(2) 6Gb mini SAS (x4) SFF 8087 Internal	(1) 6Gb mini SAS (x4) SFF 8088 External (1) 6Gb mini SAS (x4) SFF 8087 Internal
Max. Cable Length (SAS/SATA) ¹	10m/1m	10m/1m	10m/1m
Low-Profile Form Factor	Yes	Yes	Yes
Developer's Kit ² (Target Mode)	Yes	Yes	Yes
End Devices Supported	1024	1024	1024
Warranty	3 year	3 year	3 year

¹ 10m maximum for 12Gb passive copper cables; ATTO supports up to 100m max for active optical cables

² Available for qualified OEM sales only. Please contact your ATTO representative.

³ Cross-compatible with PCIe 3.0

Compatible software available - see page 20.

Compatible cables available.

ATTO
Solutions

HBAS
SAS/SATA

RAID
Adapters

NICHBAS

Storage
Controllers

Thunderbolt™
Adapters

Bridges

Software

6Gb SAS/SATA RAID Adapters

ATTO ExpressSAS® RAID Adapters

ExpressSAS® 6Gb/s SAS/SATA RAID adapters provide high-performance data protection to direct-attached SAS and SATA JBOD storage. With a wide variety of port configurations and RAID levels, these cards offer flexibility for the most diverse range of applications. For 30 years, ATTO's time-tested RAID technology has provided "no compromise" solutions with the highest performance and data integrity.

- Optimized for extremely low latency and high-bandwidth transfers for both data-intensive and high-transaction rate applications
- 100% performance, even during rebuilds
- Rebuilds RAID groups up to 50% faster than competitive solutions
- Uses up to 70% less power than competitive adapters, reducing overall power and cooling costs
- DriveAssure™ Technology improves system uptime because drives run longer, smoother and faster; drives are groomed to effectively extend their useful life, maximizing investment value
- CacheAssure Technology™ securely protects data in non-volatile memory during a power interruption and ensures that storage is online and stable before restoring and synchronizing data

Supports:

- Windows®, Linux® and macOS® driver support standard
- RAID levels 0, 1, 5, 6, 10, 50, 60, and JBOD
- Certified with industry leading platforms and applications

Includes:

- ATTO Advanced Data Streaming (ADS™) Technology
- ATTO DriveAssure™ Technology
- CacheAssure Technology™ (optional)
- Adaptive Path Optimization
- ATTO ConfigTool™ for customized performance settings

Complementary Products:

- ATTO ThunderLink® adapters
- ATTO CacheAssure Technology™
- ATTO premium cables



R680 with CacheAssure Technology

We engineer our products to minimize storage latency giving you the fastest data throughput (both MB/s and IOPS) available for today's demanding computing environments and applications.

ATTO ExpressSAS® 6Gb SAS/SATA RAID Adapters

Product Features	R60F	R680	R608	R644
Part Number	ESAS-R60F-000	ESAS-R680-000	ESAS-R608-000	ESAS-R644-000
Part Number w/ CacheAssure	ESAS-R60F-C00	ESAS-R680-C00	ESAS-R608-C00	ESAS-R644-C00
SAS/SATA Ports	16	8	8	8
Port Config. (Ext/Int)	0/16	8/0	0/8	4/4
Max. Data Rate	6Gb/s	6Gb/s	6Gb/s	6Gb/s
Bus Type	PCIe 2.0 ¹ x8	PCIe 2.0 ¹ x8	PCIe 2.0 ¹ x8	PCIe 2.0 ¹ x8
Connector Type	(4) 6Gb mini SAS (x4) SFF 8087 Internal	(2) mini SAS (x4) SFF 8088 External	(2) mini SAS (x4) SFF 8087 Internal	(1) mini SAS (x4) SFF 8088 External (1) mini SAS (x4) SFF 8087 Internal
Max. Cable Length (SAS/SATA)	10m/1m	10m/1m	10m/1m	10m/1m
Low-Profile Form Factor	Yes	Yes	Yes	Yes
End Devices Supported	256	256	256	256
Memory (ECC)	1GB	1GB	1GB	1GB
Warranty	3 year	3 year	3 year	3 year

¹ Cross-compatible with PCIe 3.0

Compatible software available - see page 20.

Compatible cables available.

Note: CacheAssure is available as a field upgradable unit for existing 6Gb RAID users. Contact your ATTO representative.

ATTO
Solutions

HBAS

RAID
Adapters

NIC/HBAS

Storage
Controllers

Thunderbolt™
Adapters

Bridges

Software

10/25/40/50/100 Gigabit Ethernet Adapters

ATTO FastFrame™ Network Interface Cards (NICs)

ATTO FastFrame™ NICs provide unmatched performance, industry-lowest latency and the versatility needed to support the most demanding and complex ecosystems. Supporting line speeds of up to 100GbE and latency as low as 1μs, FastFrame 3 NICs are suitable for media & entertainment applications, such as video post-production, finishing, imaging, archiving and workgroup file sharing, as well as IT applications such as data analytics, high performance computing (HPC) clusters, hyperconverged servers and large database analysis.

ATTO uses the latest controller technology to accelerate data I/O and deliver industry-leading performance. With end-to-end Quality of Service algorithms built into the product, network congestion is greatly reduced, even over long distances. Additionally, FastFrame have built-in hardware offload engines, including CPU transport layer offload and NVMe over Fabric target offload to accelerate data and reduce server overhead.

In addition to FastFrame, we offer a full line of legacy FastFrame NIC products that provide end-to-end connectivity options for the most cost-effective and flexible network solution.

- FastFrame NICs leverage ATTO Advanced Data Streaming (ADS™) Technology to provide high-bandwidth and managed latency for high-performance, enterprise-level iSCSI storage as well as standard 10GbE network infrastructures
- FastFrame cards support “energy efficient Ethernet” and are up to 30% more efficient in their power consumption than competitive products
- FastFrame NICs are available in a variety of port configurations, including single-, dual-, and quad- channel options to support diverse operating environments

Supports:

- macOS®, Windows®, Linux®, FreeBSD, VMware® and illumos
- Data Center Bridging (DCB) Ethernet
- Accelerated RDMA/RoCE and iSER Support
- iSCSI initiators software (optional)
- Certified with industry leading platforms and applications

Includes:

- Advanced Data Streaming (ADS™) Technology
- Pluggable optical SFP+/QSFP+/QSFP28 support

Complementary Products:

- ATTO ThunderLink® adapters
- ATTO XstreamCORE™ storage controllers
- ATTO XtendSAN™ iSCSI initiator
- ATTO premium cables



Based on industry-standard Ethernet technology, ATTO FastFrame NICs are available in single, dual, and quad-port configurations.

ATTO FastFrame™ 3 Optical Network Interface Cards

Product Features	N351	N352	N311	N312
Part Number	FFRM-N351-DA0	FFRM-N352-DA0	FFRM-N311-DA0	FFRM-N312-DA0
Max. Data Rate	50Gb/s	50Gb/s	100Gb/s	100Gb/s
Supported Speeds	1/10/25/40/50 Gb/s	1/10/25/40/50 Gb/s	1/10/25/40/50/100 Gb/s	1/10/25/40/50/100 Gb/s
Bus Type	PCIe 3.0 x8	PCIe 3.0 x8	PCIe 3.0 x16	PCIe 3.0 x16
Connector Type	QSFP28	QSFP28	QSFP28	QSFP28
Low-Profile Form Factor	Yes	Yes	Yes	Yes
Warranty	3 year	3 year	3 year	3 year

ATTO FastFrame™ Optical Network Interface Cards

Product Features	N514	N512	N511	NQ42	NQ41
Part Number	FFRM-N514-000	FFRM-N512-000	FFRM-N511-000	FFRM-NQ42-000	FFRM-NQ41-000
10GbE Ports	4	2	1	0	0
40GbE Ports	0	0	0	2	1
Max. Data Rate	10Gb/s	10Gb/s	10Gb/s	40Gb/s	40Gb/s
Bus Type	PCIe 2.0 ¹ x8	PCIe 2.0 ¹ x8	PCIe 2.0 ¹ x8	PCIe 3.0 x8	PCIe 3.0 x8
Connector Type	Optical SFP+ LC	Optical SFP+ LC	Optical SFP+ LC	Optical QSFP+	Optical QSFP+
Low-Profile Form Factor	—	Yes	Yes	Yes	Yes
Warranty	3 year	3 year	3 year	3 year	3 year

ATTO FastFrame™ 10GBASE-T Network Interface Cards

Product Features	NT12	NT11
Part Number	FFRM-NT12-000	FFRM-NT11-000
10GbE Ports	2	1
Max. Data Rate	10Gb/s	10Gb/s
Bus Type	PCIe 2.0 ¹ x8	PCIe 2.0 ¹ x8
Connector Type	RJ45	RJ45
Low-Profile Form Factor	Yes	Yes
Warranty	3 year	3 year
Warranty	3 year	3 year

¹ Cross-compatible with PCIe 3.0
Compatible software available - see page 20.
Compatible cables available.

Use Case iSCSI SAN Configuration

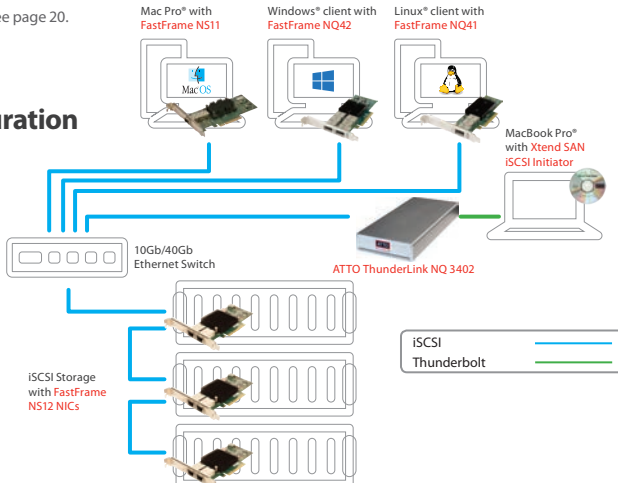

ATTO
Solutions

HBAs

RAID
Adapters

NIC HBAs
Ethernet

Storage
Controllers

Thunderbolt™
Adapters

Bridges

Software

ATTO develops high-performance products that manage latency in the application performance, enhanced transaction processing

Enterprise - IOPS

Database | ERP | Web Servers | Email Servers | Back-Office Operations

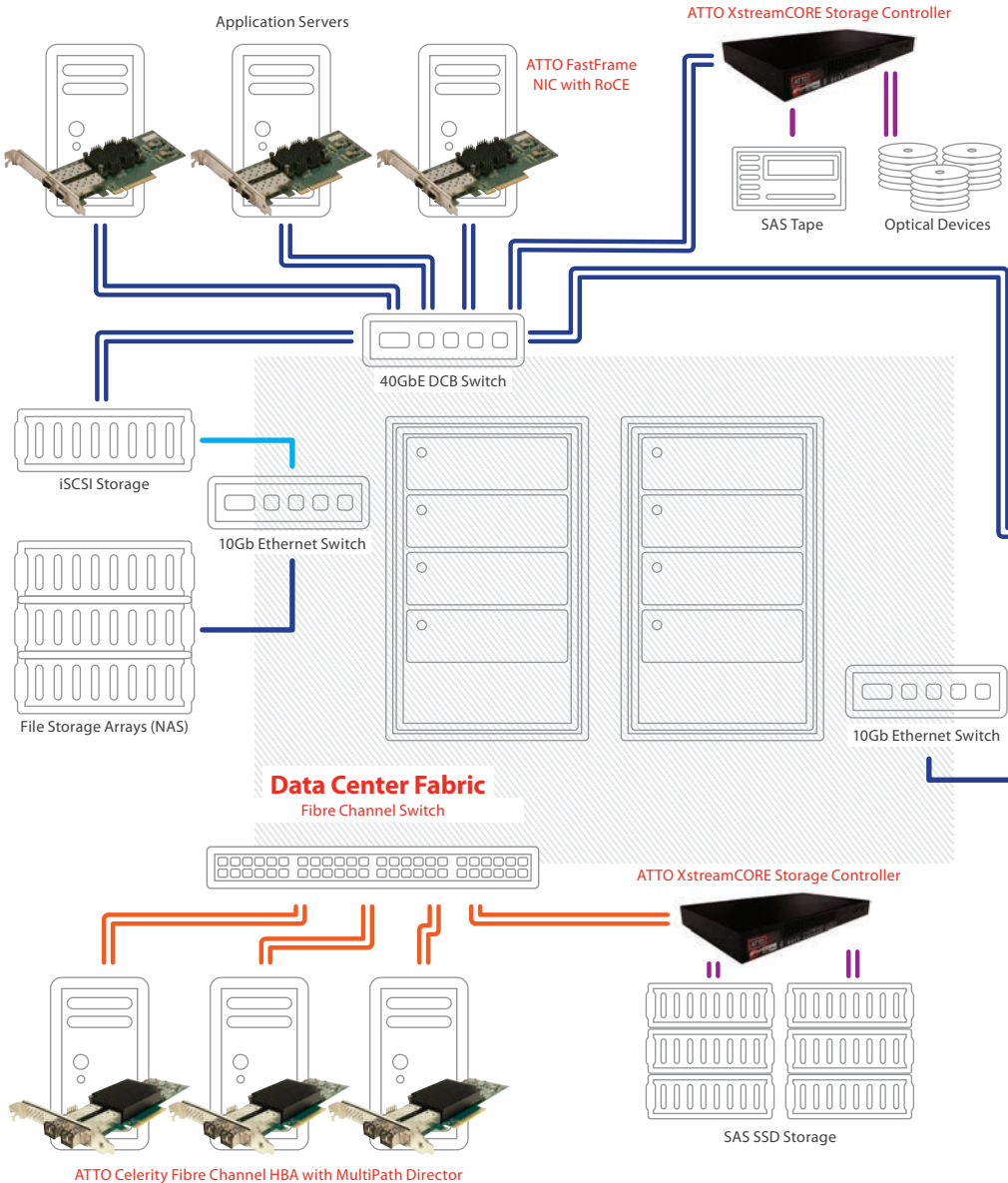

ATTO components are designed to work seamlessly together to deliver maximum performance for specific workgroups to large-scale enterprise infrastructures. ATTO delivers the products that are certified for interoperability with industry leading servers

the most demanding, real-time environments resulting in accelerated performance and the ability to handle large workloads and client counts.

Departmental - Mixed Environment

Business Analytics | Financial/OLTP
Supply Chain | Asset Management | Operations

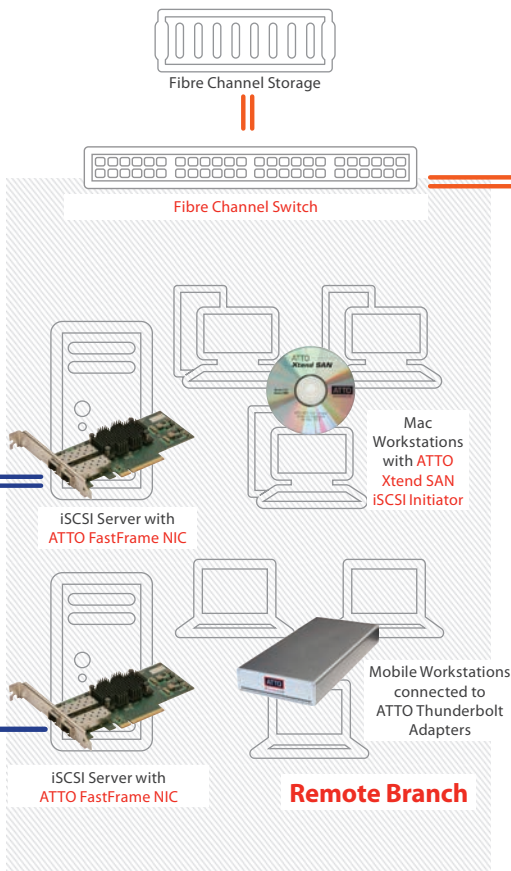

Workgroup - MB/sec

CAD/CAE | Video Production/Broadcast
Medical Imaging | Seismic/Oil & Gas

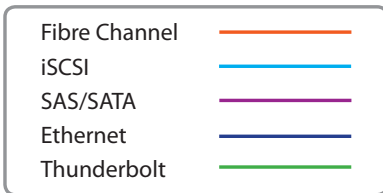
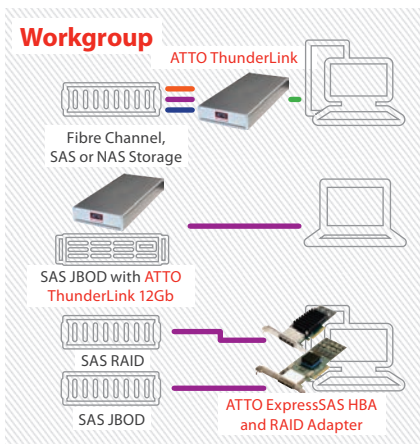
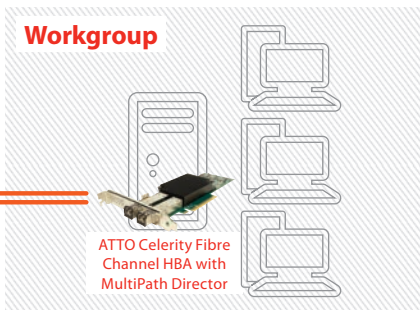

imum performance for bandwidth-intensive environments from application- most extensive portfolio of high-performance storage and network connectivity r, tape and disk storage, and workstation, server and application vendors.

Storage Controllers

ATTO XstreamCORE™ Fibre Channel to SAS and Ethernet to SAS storage controllers

ATTO XstreamCORE™ storage controllers are high-performance accelerated protocol conversion appliances which add shared storage benefits to SAS storage enabling storage owners to disaggregate storage from server hardware using JBOD, JBOF, RAID or tape storage. Use cases include mapping one or many individual drives to space-limited rack or blade servers, remapping attached drives from failed servers to replacement servers, adding shared capabilities to direct-attached storage, creating mass shared storage using commodity storage and remotely locating direct attached disk or tape devices.

- Optimized for high performance with xCORE Data Acceleration, XstreamCORE provides industry-leading performance for up to 64 servers with less than 2 microseconds of added latency. Users will benefit from very high, reliable throughput and IOPS.
- eCORE Control Engine adds common services and failures, integrates with open storage services, integrates with standard APIs, handles reservations and mapping.
- ATTO storage controllers keep overall storage solutions flexible without locking users into proprietary hardware implementations. The ATTO storage controller is a modular building block with technology that allows admins to reduce resource load while decoupling storage from server resources.

Supports:

- Full-duplex data transfers
- Error recovery
- Certified with industry leading platforms and applications
- Data Mover functionality
- VMware® Ready

Includes:

- xCORE Data Acceleration
- eCORE Control Engine
- Parallel Data Processing
- Pluggable optical SFP+/QSFP+ modules
- XstreamVIEW™ web-based GUI simplifies management, monitoring and diagnostics

Complementary Products:

- ATTO Celernity™ Fibre Channel HBAs
- ATTO FastFrame™ Ethernet NICs
- ATTO ThunderLink® adapters



XstreamCORE FC 7500



"The XstreamCore FC 7550 has allowed Torcon the flexibility to expand our storage without having to completely re-architect the current setup."

*– Shawn Winters
Director of Technology, Torcon*

ATTO XstreamCORE™ Fibre Channel and Ethernet Storage Controllers

Product Features	8200	7600	7550	7500
Part Number	XCEI-8200-002	XCFC-7600-002	XCFC-7550-004	XCFC-7500-002
Max Sustained Transfer Rate	6000 MB/s	6000 MB/s	6000 MB/s	3200 MB/s
4K IOPS	1,200,000	1,200,000	1,200,000	750,000
Input Connectors	(2) 40Gb Ethernet QSFP+ (ISER Support)	(2) 32Gb Fibre Channel SFP+	(4) 16Gb Fibre Channel SFP+	(2) 16Gb Fibre Channel SFP+
Output Connectors	(4) 12Gb HD Mini SAS (x4) SFF 8644	(4) 12Gb HD Mini SAS (x4) SFF 8644	(4) 12Gb HD Mini SAS (x4) SFF 8644	(4) 12Gb HD Mini SAS (x4) SFF 8644
Management Ports	RS-232/RJ45/USB	RS-232/RJ45/USB	RS-232/RJ45	RS-232/RJ45
Ethernet Management Protocols	IPv4, IPv6	IPv4, IPv6	IPv4, IPv6	IPv4, IPv6
xCORE Data Acceleration	Yes	Yes	Yes	Yes
eCORE Control Engine	Yes	Yes	Yes	Yes
Data Mover Support	Yes	Yes	Yes	Yes
Devices supported	Up to 240 (960 OEM)	Up to 240 (960 OEM)	Up to 240 (960 OEM)	Up to 240 (960 OEM)
Active initiator Support	Up to 1024	64	64	64
Event Log Protection	NVRAM	NVRAM	NVRAM	NVRAM
Expander/Port Multiplier support	Yes	Yes	Yes	Yes
Form Factor	1U Rackmount	1U Rackmount	1U Rackmount	1U Rackmount
Power Supplies	2 Hot Swap	2 Hot Swap	2 Hot Swap	2 Hot Swap
Disk Support	Yes	Yes	Yes	Yes
Tape Support	Yes	Future	Future	Yes
Warranty	2 year	2 year	2 year	2 year

Compatible cables and accessories available.

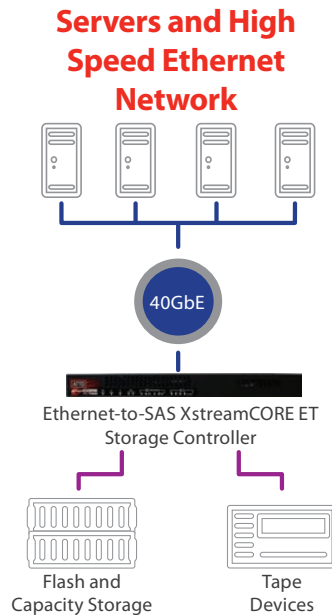
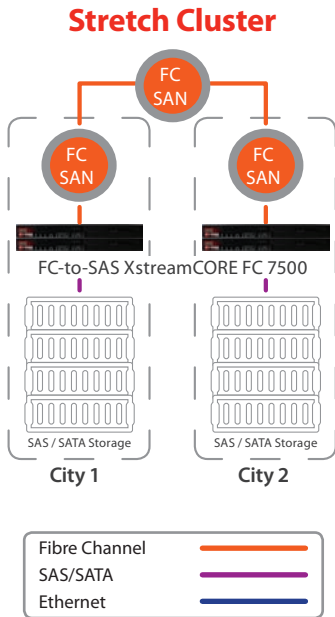

ATTO Solutions

HBAs

RAID Adapters

NIC/HBAs

Storage Controllers

Thunderbolt™ Adapters

Bridges

Software

Thunderbolt™ Adapters

ATTO ThunderLink®

Delivering creative, engineering and technical professionals a high-performance and low latency Thunderbolt™ connectivity solution engineered for applications where optimized performance and high throughput are essential. ATTO ThunderLink® adapters allow today's Thunderbolt enabled desktop and mobile workstations to connect into high-performance storage or networks. ATTO provides the widest portfolio of Fibre Channel, SAS/SATA and Ethernet adapters for both Thunderbolt 3 and Thunderbolt 2 connectivity.

- Purpose built to be low profile, cool, ultra-quiet and simple to deploy into existing environments
- All units are equipped with any needed SFP+/QSFP+, locking power supply and Kensington™ security slot
- Widest portfolio available of tested and certified solution components including storage systems, switches, hosts and software applications



ThunderLink

ThunderLink Supports:

- macOS®, Windows®, VMware® (16 and 8Gb)
- Certified with industry leading platforms and applications
- DisplayPort (including 5K), hot plug, daisy chain

Includes:

- Advanced Data Streaming (ADS™) Technology
- ATTO ConfigTool™ for customized performance settings
- MultiPath Director™

Complementary Products:

- ATTO Celerity™ Fibre Channel HBAs
- ATTO ExpressSAS® HBAs and RAID Adapters
- ATTO FastFrame™ NICs
- ATTO XstreamCORE™ Storage Controllers
- ATTO FibreBridge® Fibre Channel Bridges
- ATTO premium cables and accessories

"With Thunderbolt Macs, you can't put a Fibre Channel card in, so ATTO ThunderLink adapters ended up being really crucial for both moving material around, and doing a conform and grade."

*– Marcus Von Holtzendorff
Mel Hoppenheim School of Cinema*

ATTO ThunderLink® Adapters - Thunderbolt 3

Product Features	40GbE	40GbE	Fibre Channel	Fibre Channel	10GbE	10GbE	SAS/SATA
Part Number	TLNQ-3402-D00/DE0 ¹	TLNQ-3401-D00/DE0	TLFC-3322-D00/DE0	TLFC-3162-D00/DE0	TLNS-3102-D00/DE0	TLNS-3101-D00/DE0	TLSH-3128-D00/DE0
Input Connectors	(2) 40Gb/s Thunderbolt (USB-C)	(2) 40Gb/s Thunderbolt (USB-C)	(2) 40Gb/s Thunderbolt (USB-C)	(2) 40Gb/s Thunderbolt (USB-C)	(2) 40Gb/s Thunderbolt (USB-C)	(2) 40Gb/s Thunderbolt (USB-C)	(2) 40Gb/s Thunderbolt (USB-C)
Output Connectors	(2) 40GbE	(1) 40GbE	(2) 32Gb/s Fibre Channel	(2) 16Gb/s Fibre Channel	(2) 10GbE	(1) 10GbE	(2) 12Gb SAS/SATA
Connector Type	(2) QSFP+ (Included)	(1) QSFP+ (Included)	(2) Optical SFP+LC (Included)	(2) Optical SFP+LC (Included)	(1) Optical SFP+LC (Included)	(2) Optical SFP+LC (Included)	(2) mini SAS (x4) SFF 8644 External
Warranty	3 year	3 year	3 year	3 year	3 year	3 year	3 year

ATTO ThunderLink Adapters - Thunderbolt 2

Product Features	Fibre Channel	Fibre Channel	10GBASE-T	10GbE	10GbE
Part Number	TLFC-2162-D00/DE0 ¹	TLFC2082-D00/DE0 ¹	TLNT-2102-D01/DE1 ¹	TLNS-2102-D01/DE1 ¹	TLNS-2101-D00/DE0 ¹
Input Connectors	(2) 20Gb/s Thunderbolt	(2) 20Gb/s Thunderbolt	(2) 20Gb/s Thunderbolt	(2) 20Gb/s Thunderbolt	(2) 20Gb/s Thunderbolt
Output Connectors	(2) 16Gb/s Fibre Channel	(2) 8Gb/s Fibre Channel	(2) 10GbE	(2) 10GbE	(1) 10GbE
Connector Type	(2) Optical SFP+LC (Included)	(2) Optical SFP+LC (Included)	(2) RJ45	(2) Optical SFP+LC (Included)	(1) Optical SFP+LC (Included)
Warranty	3 year	3 year	3 year	3 year	3 year

¹ Includes UK/EMEA power components, accessories
Compatible cables and accessories available.

Use Case

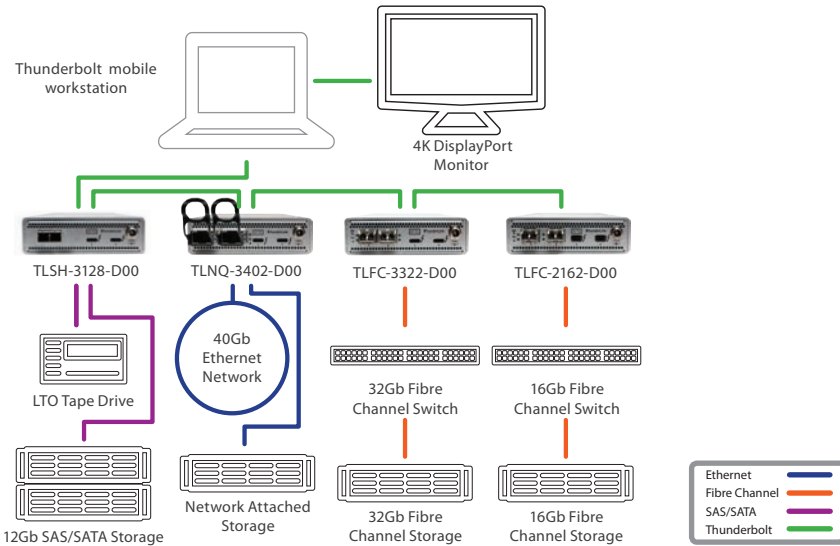

ATTO
Solutions

HBAS

RAID
Adapters

NIC/HBAS

Storage
Controllers

Thunderbolt™
Adapters

Bridges

Software

Fibre Channel-to-SAS Bridges

ATTO FibreBridge® Fibre Channel to SAS Bridges

ATTO FibreBridge® allows the use of direct-attached SAS/SATA disk or tape storage devices in a Fibre Channel SAN environment while providing management and monitoring capabilities not available in direct connect or native technologies. ATTO bridges are engineered to integrate with and are fully compliant with Fibre Channel and SAS specifications to assure easy installation and flawless operation. ATTO offers enterprise-class intelligent bridging products that allow you to keep your infrastructure in place without the need to rip and replace and allows the use of existing technology as the industry changes and new technology as your organizational needs change.

- Compatible with all SAS/SATA storage devices including JBODs, hard disk drives, SSD, tape libraries, RAID arrays and RAID controllers
- Includes patented ATTO Drive Map Director™, which reduces down time during drive maintenance by keeping the existing network topology available without having to re-map the LUN structure of the SAN
- Lower solution and operational costs with reduced need for many Fibre Channel components and low power consumption which reduces overall electric and cooling costs

Supports:

- Full-duplex Fibre Channel data transfers
- Error recovery
- Certified with industry leading platforms and applications

Includes:

- Pluggable optical SFP+ modules
- Dual Power Supplies
- ATTO ExpressNAV™ web-based GUI simplifies management, monitoring and diagnostics

Complementary Products:

- ATTO Celerity™ Fibre Channel HBAs



6500 1U Rackmount

ATTO FibreBridge® products are performance tuned, highly manageable, intelligent devices which allow fibre channel initiators to communicate with SAS/SATA target devices with very low latency.

ATTO FibreBridge® Fibre Channel Bridges

Product Features	6500
Part Number	FCBR-6500-D00
Max Sustained Transfer Rate	1200 MB/s
Input Connectors	(2) 8Gb Fibre Channel SFP+
Output Connectors	(2) 6Gb Mini SAS (x4) SFF 8088 External
Devices supported	240
Active initiator Support	64
Event Log Protection	NVRAM
Expander/Port Multiplier support	Yes
Form Factor	1U Rackmount
Disk Support	Yes
Tape Support	Yes
Warranty	2 year

* Embedded models available to OEMs only
Compatible Cables & Accessories Available.

Use Case

Adding next generation, low cost storage technology to a SAN

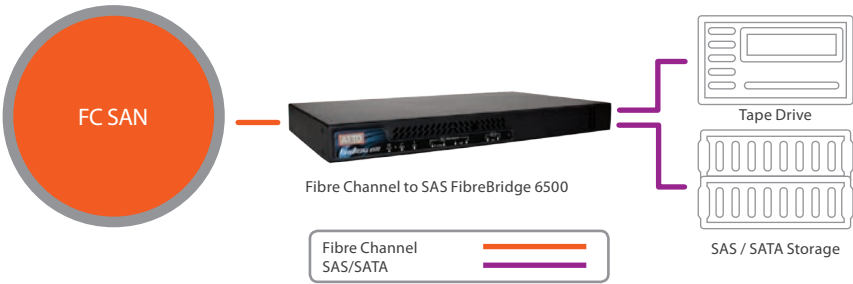

The FibreBridge® 6500 will allow you to connect newer, faster and higher capacity SAS or SATA drive technology to your existing Fibre Channel SAN. Since SAS/SATA technology is distance limited and does not natively connect to Fibre Channel SANs, a bridge must be used to allow coexistence on the SAN. The FibreBridge 6500 also provides extensive manageability and troubleshooting features not found in direct-attached technology.

ATTO
Solutions

HBAS

RAID
Adapters

NIC/HBAS

Storage
Controllers

Thunderbolt™
Adapters

Bridges

Software

Software

ATTO Xtend SAN™ and Disk Benchmark

Xtend SAN

ATTO Xtend SAN iSCSI Initiator for macOS® software connects workstations with built-in Ethernet to multiple direct-attached storage servers across long distances. It provides users with network access to block-level storage without the cost and complexity of a Fibre Channel SAN. With iSCSI, small businesses and workgroups gain the advantages of a SAN on a manageable budget.

- Easy setup and management features make implementing an iSCSI SAN simple
- High performance for demanding applications
- EMC® E-Lab Certified
- Compatible with 32/64 bit macOS®
- Volume and enterprise licensing available

ATTO Disk Benchmark

The ATTO Disk Benchmark is the world's most widely used performance measurement tool. Measure your storage system performance with various transfer sizes and test lengths for reads and writes. Several options are available to customize your measurement including a comparison mode to analyze various performance tests. Use ATTO Disk Benchmark to test HDD and SSD drives and to tune for maximum performance.

- Transfer sizes from 512KB to 8MB
- Transfer lengths from 64KB to 2GB
- Support for overlapped I/O
- Supports a variety of queue depths

Supports:

- Up to 1024 targets
- Header/Data digest with class 1 error recovery
- SNS client login redirect function
- CHAP iSCSI security
- iSNS client
- Certified with industry leading platforms and applications

Includes:

- Easy-to-use GUI simplifies set-up, configuration and management
- Advanced CLI for addressing iSCSI targets
- Voluming Licensing available

Complementary Products:

- ATTO FastFrame™ NICs
- ATTO ThunderLink® adapters

Part Number:

- INIT-MAC0-001

Visit atto.com to find the right software to maximize the performance of your storage connection.

Management Tools

ATTO ConfigTool™, vConfigTool™ and XstreamVIEW™

ConfigTool™

ATTO ConfigTool helps customize the settings of your ATTO host bus adapter (HBA) to maximize the performance of your storage connection. ConfigTool comes standard with all ATTO HBAs and Thunderbolt™ adapters. While the factory settings on your host adapter provide excellent performance for a wide range of applications, some specialized applications may benefit from adjustment of the adapter settings to tune for a specific performance range.

- Custom utility settings to optimize performance
- Available on macOS®, Windows® and Linux®
- Advanced troubleshooting and monitoring

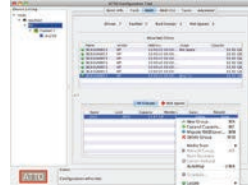

vConfigTool™

ATTO vConfigTool for VMware® vCenter Server is a software plug-in that integrates centralized management and monitoring of ATTO Celerity™ and ATTO ExpressSAS® host adapters into VMware virtual environments. This accelerates adapter deployments, optimizes configurations, improves system availability and reduces infrastructure costs. vConfigTool includes Latency Scout™, an I/O latency statistic feature that enables IT administrators to quickly make adjustments within the data center to maximize performance. Real-time histograms allow administrators to monitor storage I/O latency and isolate bottlenecks.

- Custom utility settings to optimize performance
- Available for VMware vCenter Server
- Advanced troubleshooting and monitoring

XstreamVIEW™

ATTO XstreamVIEW System Manager user interface allows administrators to remotely manage, set up and configure the storage controller while providing storage performance metrics, Data Mover traffic statistics, storage and host LUN mapping and diagnostic tools. ATTO XstreamCORE™ Fibre Channel and Ethernet storage controllers equipped with XstreamVIEW, help manage complete storage infrastructures via a single user interface.

- Advanced performance tuning
- Email notification for monitoring
- Event logging



ATTO
Solutions

HBAs

RAID
Adapters

NIC/HBAs

Storage
Controllers

Thunderbolt™
Adapters

Bridges

Software

Glossary

Adaptive Path Optimization

Intelligently senses multiple paths to drives and increases I/O for up to a 70% performance improvement. Also eliminates single points of failure in storage connections.

CacheAssure Technology™

Uses supercap technology to protect cached data for up to 10 years. Manages data during power up and power down. Eliminates battery-related maintenance, reducing IT costs.

Data Mover

Patented technology that pre-processes data to allow for accelerated movement of data between storage devices while freeing up server CPU, memory and storage interfaces.

Drive Map Director™

Provides a logical, static topology and enables login parameters, access management and security for racks of SAS/SATA storage during configuration or maintenance, reducing additional administration costs and resources.

DriveAssure™ Technology

Repairs drives to prevent premature failures and slowdowns to maximize system uptime. Also ensures 100% throughput during data rebuilds.

DVRAID™

Technology optimized for digital content creation environments which require protection in the event of a disk failure without the performance penalty traditionally seen with parity RAID.

intelligent Controller Architecture™

Combines powerful hardware with an efficient data engine to create a platform that delivers performance with a rapid IO ramp and extremely low latency.

Latency Scout™

Enables IT administrators to quickly isolate datacenter bottlenecks with real-time latency histograms, ensuring maximum infrastructure uptime and optimal performance.

MultiPath Director™

A proprietary technology available on ATTO Fibre Channel host bus adapters and Thunderbolt™ adapters that enables Linux®, macOS® and Windows® workstations and servers to connect directly to enterprise-class storage with redundant controllers, providing failover and load balancing capabilities across multiple paths to the storage.

xCORE Acceleration Platform

Features multiple parallel I/O acceleration engines with end-to-end I/O processing, hardware buffer allocation management and real-time performance and latency analytics.

eCORE Control Engine

Adds common, open storage and management services, integrates with industry standard APIs, handles reservations, storage routing and host and LUN mapping functions.

Power Center Pro

Easy-to-use, integrated software RAID solution that brings the performance and protection of RAID 0, 1, 1e and 10 to storage devices connected to ATTO host adapters.

Virtual Device Manager™

Virtualizes devices in one protocol so they can be managed by a controller of a different protocol.

WriteStop™

Ensures data security in digital forensics applications by blocking writes to hard disks, while providing read-only protection at the system level.

Resources

How to Buy, Interoperability, Support, Partner Programs

ATTO Resources page contains our latest press releases, videos, success stories, case studies, images and more. Please visit www.atto.com/resources/

How to Buy

On the web: www.atto.com/howtobuy

Main Number: +1.716.691.1999

Channel Sales: Extension 240

International Sales: Extension 239

OEM Sales: Extension 241

Direct Sales: www.atto.com

VARs and System Integrators can also purchase ATTO products from the How To Buy page.

Interoperability

ATTO continually certifies our products with third-party vendor products to ensure full compatibility. Please visit www.atto.com/support/interoperability for compatibility listings.

Support

ATTO provides customers with the finest in technical support for the lifetime of all product lines. It is our priority to understand customer workflows and their specific needs to provide the best technical assistance in the industry. Contact ATTO Technical Support at **+1.716.691.1999**, extension 242, or to submit an inquiry please visit our website: www.atto.com/corporate/contact-us/

Partner Programs

ATTO Technology Access™ Partner Program offers technical partners opportunities to engage in high-performance markets with fully tested solutions. Access members benefit from interoperability testing, technology access and co-marketing support.

ATTO Technology Accelerate™ Partner Program rewards our dedicated solution providers with outstanding support in all key collaborative areas such as sales, marketing, training and more. It provides a higher level of engagement and tools to help you reach your business objectives.

Always Have the Latest Edition

See the newest additions to the ATTO product portfolio
by visiting atto.com/ProductBrochure

Be sure to follow us on Social Media





The Power Behind the Storage

155 CrossPoint Parkway

Amherst, NY 14068

p. +1.716.691.1999

f. +1.716.691.9353

atto.com/ProductBrochure